

TECHNICAL SPECIFICATION

COLOURS

PARTITION WALLS - FABRICS ELEMENTS - FABRIC NEMO

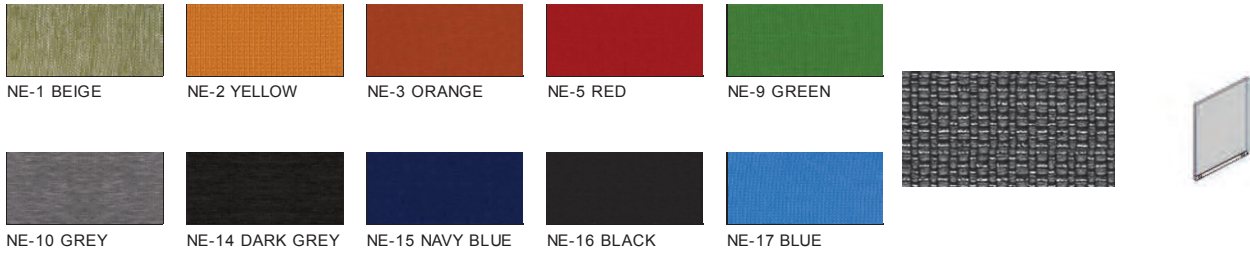

FABRIC PANEL SONIC - FABRIC NEMO

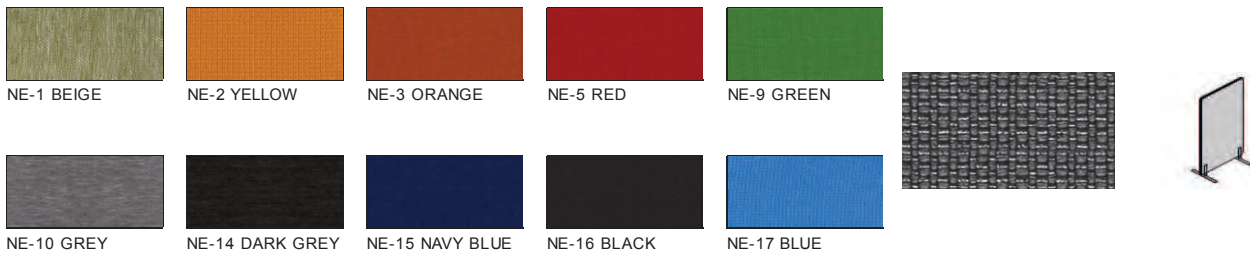

FABRIC PANEL SONIC - FABRIC RUNNER - SECOND GROUP



FABRIC PANEL SONIC - FABRIC MEDLEY - SECOND GROUP



FABRIC PANEL SONIC - FABRIC ATLANTIC - SECOND GROUP



TECHNICAL SPECIFICATION

COLOURS











FABRIC PANEL SONIC - FABRIC BLAZER - THIRD PRICE GROUP

 CUZ39 ORANGE	 CUZ63 RED	 CUZ1L GREEN	 CUZ12 GRAPHITE	 CUZ02 TURQUOISE		
 CUZ1V BLUE	 CUZ1X PINK	 CUZ1G GREY	 CUZ28 LIGHT GREY	 CUZ47 BEIGE		
 CUZ1R - SEA-GREEN						

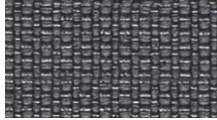
FABRIC PANEL SONIC - FABRIC XTREME - THIRD PRICE GROUP

 XR160 SEA-GREEN	 XR430 DARK TURQUOISE	 XR026 NAVY BLUE	 XR084 VIOLET	 XR9 BLACK		
 XR420 OLIVE	 XR081 DARK GREY	 XR094 GREY	 XR108 BEIGE	 XR079 RED		

FABRIC PANEL VIVA - FABRIC NEMO

 NE-1 BEIGE	 NE-2 YELLOW	 NE-3 ORANGE	 NE-5 RED	 NE-9 GREEN		
 NE-10 GREY	 NE-14 DARK GREY	 NE-15 NAVY BLUE	 NE-16 BLACK	 NE-17 BLUE		

FABRIC PANEL VIVA - FABRIC RUNNER - SECOND GROUP

 R-63034 ORANGE	 R-64089 RED	 R-66063 BLUE	 R-60011 GREY	 R-68056 GREEN		
 R-66064 NAVY-BLUE	 R-60999 BLACK	 R-60025 DARK GREY	 R-61128 BEIGE			

TECHNICAL SPECIFICATION

COLOURS

FABRIC PANEL VIVA - FABRIC MEDLEY - SECOND GROUP

M-68005 DARK OLIVE	M-68002 LIGHT OLIVE	M-68115 GREEN	M-61002 BEIGE	M-67053 NAVY BLUE		
M-67006 LIGHT BLUE	M-66008 GREY	M-6419 RED	M-63064 PINK	M-60999 BLACK		

FABRIC PANEL VIVA - FABRIC ATLANTIC - SECOND GROUP

A-67043 DARK TURQUOISE	A-67030 SEA-GREEN	A-6141 LIGHT GREY	A-611 GREY	A-66064 NAVY BLUE		
A-65037 VIOLET	A-62048 OLIVE	A-64089 RED	A-61078 BEIGE	A-625 GRAPHITE		

FABRIC PANEL VIVA - FABRIC BLAZER - THIRD PRICE GROUP

CUZ39 ORANGE	CUZ63 RED	CUZ1L GREEN	CUZ12 GRAPHITE	CUZ02 TURQUOISE		
CUZ1V BLUE	CUZ1X PINK	CUZ1G GREY	CUZ28 LIGHT GREY	CUZ47 BEIGE		
CUZ1R - SEA-GREEN						

FABRIC PANEL VIVA - FABRIC XTREME - THIRD PRICE GROUP

XR160 SEA-GREEN	XR430 DARK TURQUOISE	XR026 NAVY BLUE	XR084 VIOLET	XR9 BLACK		
XR420 OLIVE	XR081 DARK GREY	XR094 GREY	XR108 BEIGE	XR079 RED		

METAL ELEMENTS

15 HIGH GLOSS WHITE	09 ALUMINUM		
15 HIGH GLOSS WHITE	09 ALUMINUM	154 ANTHRACITE	

TECHNICAL SPECIFICATION

PARTITION WALLS

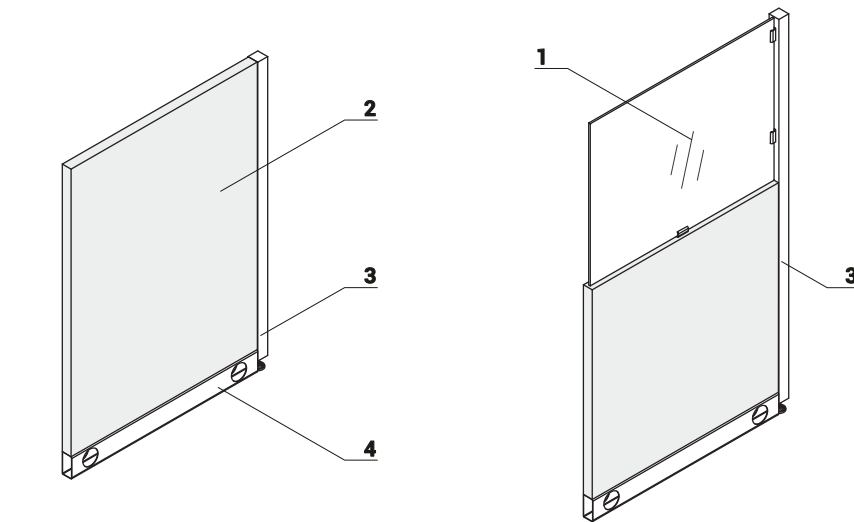

1. Tempered glass 6,4mm, transparent
2. **Partition wall** - 38mm, fabric
3. **Column** - 40x40mm or 40x80mm powder painted
4. Horizontal cable management

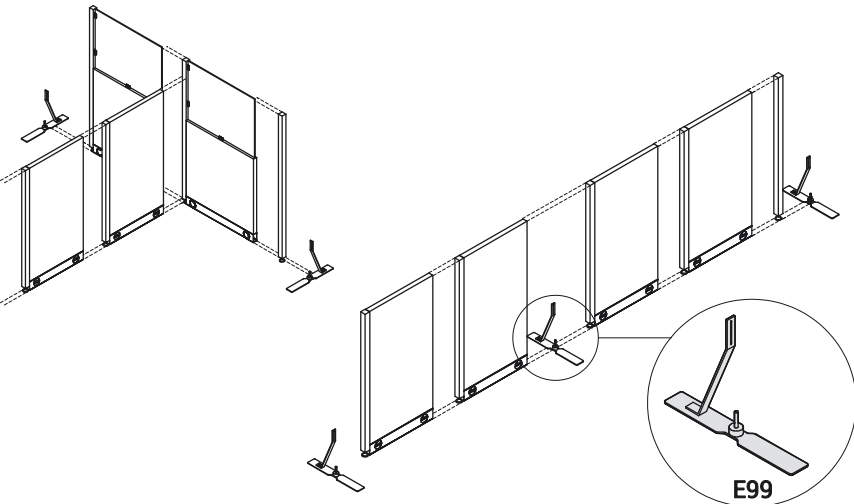

ATTENTION - Freestanding wall set needs E99 foot; for more info aks Client Service

SONIC - FREE-STANDING SCREENS

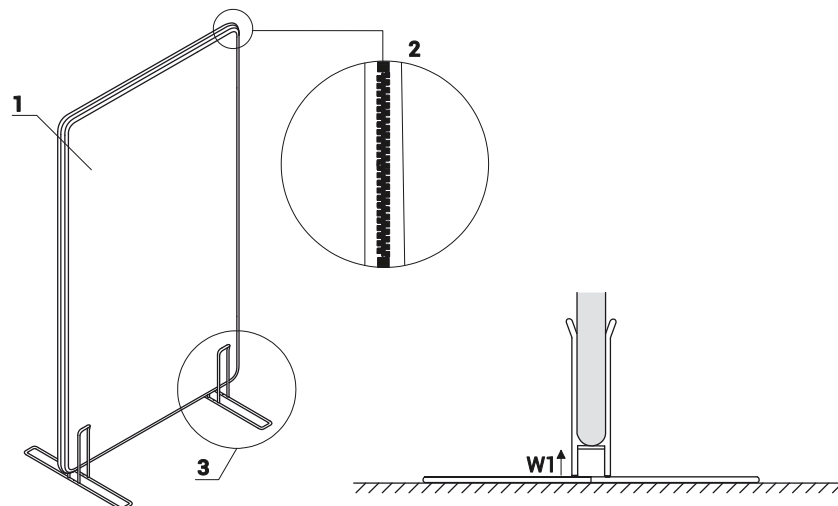

1. **Fire resistant** - accoustic class A, pinable
2. Zip fastener
3. **Foot** - powder painted metal

ATTENTION - Free standing panel in height W1 - 50mm from the bottom

TECHNICAL SPECIFICATION

CONNECTING ELEMENT FOR FREE STANDING PANELS SONIC

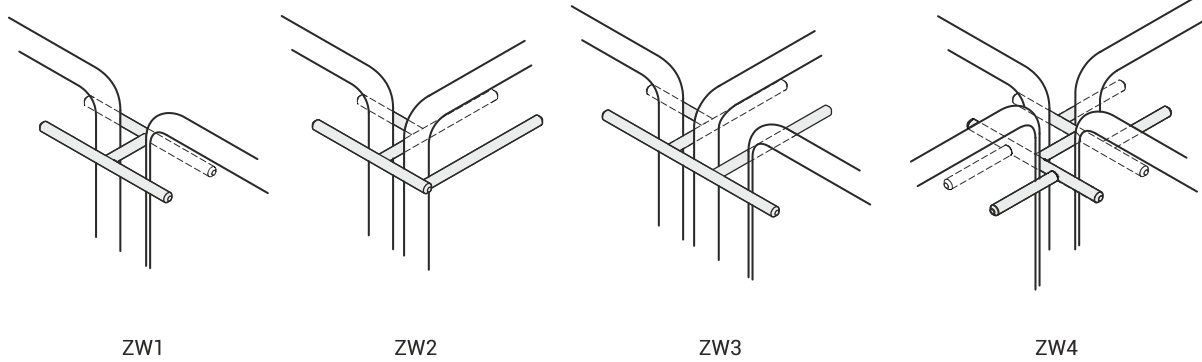

VIVA - FREE-STANDING SCREENS

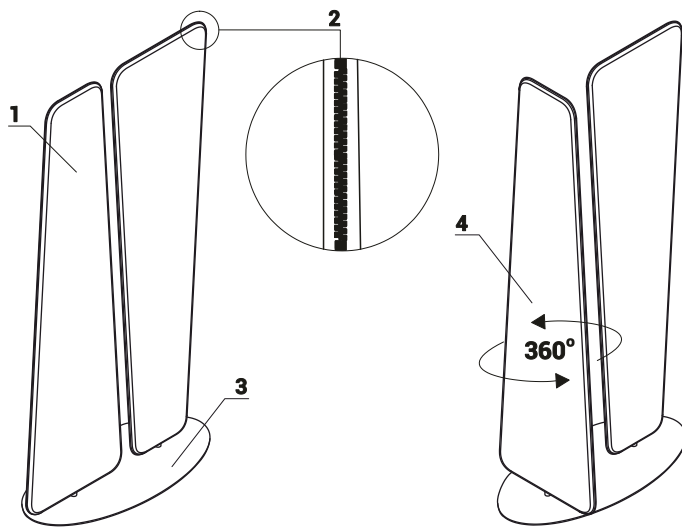

- 1. Fire resistant - pinable
- 2. Zip fastener
- 3. Foot - powder painted metal
- 4. The possibility of rotation each of the panels separately

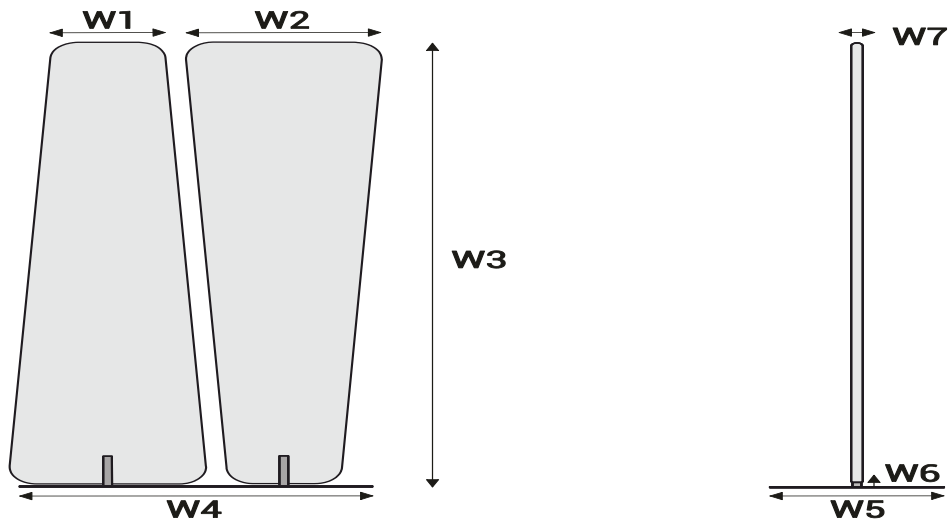

W1 - 258 | W2 - 443 | W3 - 1669 | W4 - 810 | W5 - 400 | W6 - 15 | W7 - 32

PRODUCT ILLUSTRATION	DIMENSIONS [mm]			INDEX SYMBOL						COMMENTS
	WIDTH	DEPTH	HEIGHT			kg	m3	pcs		

SONIC - FREE-STANDING SCREENS

	650	40	1250	ZW612		18.0	0.051	2		
	650	40	1450	ZW614		19.0	0.058	2		
	650	40	1650	ZW616		20.0	0.065	2		
	650	40	1850	ZW618		21.0	0.071	2		
	800	40	1250	ZW812		16.0	0.061	2		
	800	40	1450	ZW814		17.0	0.069	2		
	800	40	1650	ZW816		18.0	0.077	2		
	800	40	1850	ZW818		19.0	0.085	2		

DESCRIPTION

- NET WEIGHT

VOLUME

NUMBER OF PACKAGES

PRODUCT ILLUSTRATION	DIMENSIONS [mm]			INDEX SYMBOL						COMMENTS
	WIDTH	DEPTH	HEIGHT			kg	m3	pcs		

CONNECTING ELEMENT FOR FREE STANDING PANELS SONIC

	52	128	8	ZW1		0.1	0.000	1		For two panels
	121	113	8	ZW2		0.2	0.000	1		For two panels
	121	173	8	ZW3		0.2	0.000	1		For three panels
	172	128	8	ZW4		0.2	0.000	1		For four panels

VIVA - FREE-STANDING SCREENS

	850	400	1670	VV02		19.7	0.084	3		
--	-----	-----	------	-------------	--	------	-------	---	--	--

PRODUCT ILLUSTRATION	DIMENSIONS [mm]			INDEX SYMBOL						COMMENTS
	WIDTH	DEPTH	HEIGHT			kg	m3	pcs		

FABRIC PARTITION WALLS CUBIC



	403	40	1100	UE512		12.0	0.023	1		walls with post 40/40mm
	600	40	1100	UE52		18.0	0.028	1		walls with post 40/40mm
	800	40	1100	UE53		23.0	0.037	1		walls with post 40/40mm
	1000	40	1100	UE535		23.0	0.045	1		walls with post 40/40mm
	1200	40	1100	UE54		38.0	0.068	1		walls with post 40/40mm
	443	40	1100	UE612		14.0	0.025	1		walls with post 80/40mm
	640	40	1100	UE62		20.0	0.036	1		walls with post 80/40mm
	840	40	1100	UE63		26.0	0.047	1		walls with post 80/40mm
	1040	40	1100	UE635		23.0	0.045	1		walls with post 80/40mm

DESCRIPTION









- NET WEIGHT

VOLUME

NUMBER OF PACKAGES

PRODUCT ILLUSTRATION	DIMENSIONS [mm]			INDEX SYMBOL						COMPONENTS
	WIDTH	DEPTH	HEIGHT			kg	m3	pcs		

FABRIC PARTITION WALLS CUBIC

	1240	40	1100	UE64		37.8	0.069	1		walls with post 80/40mm
	403	40	1400	UE712		16.0	0.029	1		walls with post 40/40mm
	600	40	1400	UE72		18.8	0.043	1		walls with post 40/40mm
	800	40	1400	UE73		23.0	0.045	1		walls with post 40/40mm
	1000	40	1400	UE735		23.0	0.057	1		walls with post 40/40mm
	1200	40	1400	UE74		33.0	0.067	1		walls with post 40/40mm
	443	40	1400	UE812		17.0	0.032	1		walls with post 80/40mm
	640	40	1400	UE82		25.2	0.046	1		walls with post 80/40mm
	840	40	1400	UE83		32.8	0.060	1		walls with post 80/40mm

DESCRIPTION

 - NET WEIGHT

 VOLUME

 NUMBER OF PACKAGES

PRODUCT ILLUSTRATION	DIMENSIONS [mm]			INDEX SYMBOL						COMMENTS
	WIDTH	DEPTH	HEIGHT			kg	m3	pcs		

FABRIC PARTITION WALLS CUBIC

	1040	40	1400	UE835		32.8	0.074	1		walls with post 80/40mm
	1240	40	1400	UE84		47.9	0.088	1		walls with post 80/40mm
	403	40	1850	UE352		20.0	0.039	1		walls with post 40/40mm
	600	40	1850	UE36		28.5	0.045	1		walls with post 40/40mm
	800	40	1850	UE37		37.7	0.060	1		walls with post 40/40mm
	1000	40	1850	UE375		37.7	0.075	1		walls with post 40/40mm
	1200	40	1850	UE38		50.0	0.090	1		walls with post 40/40mm
	443	40	1850	UE452		21.0	0.042	1		walls with post 80/40mm
	640	40	1850	UE46		30.4	0.048	1		walls with post 80/40mm

DESCRIPTION

- NET WEIGHT

VOLUME

NUMBER OF PACKAGES

PRODUCT ILLUSTRATION	DIMENSIONS [mm]			INDEX SYMBOL						COMMENTS
	WIDTH	DEPTH	HEIGHT			kg	m3	pcs		

FABRIC PARTITION WALLS CUBIC

	840	40	1850	UE47		39.6	0.063	1		walls with post 80/40mm
	1040	40	1850	UE475		39.6	0.078	1		walls with post 80/40mm
	1240	40	1850	UE48		57.9	0.093	1		walls with post 80/40mm

FOOT

	70	500	360	E99		1.0	0.002	1		foot for partition walls
--	----	-----	-----	------------	--	-----	-------	---	--	--------------------------

PRODUCT ILLUSTRATION	DIMENSIONS [mm]			INDEX SYMBOL						COMMENTS
	WIDTH	DEPTH	HEIGHT			kg	m3	pcs		

PARTITION WALLS WITH GLASS CUBIC



	600	40	1400	UESO36		21.4	0.058	2		walls with post 40/40mm, transparent safety glass
	800	40	1400	UESO37		27.4	0.078	2		walls with post 40/40mm, transparent safety glass
	1200	40	1400	UESO38		38.4	0.117	2		walls with post 40/40mm, transparent safety glass
	640	40	1400	UESO46		23.0	0.062	2		walls with post 80/40mm, transparent safety glass
	840	40	1400	UESO47		29.0	0.082	2		walls with post 80/40mm, transparent safety glass
	1240	40	1400	UESO48		40.0	0.121	2		walls with post 80/40mm, transparent safety glass
	600	40	1850	UESO72		38.0	0.085	2		walls with post 40/40mm, transparent safety glass
	800	40	1850	UESO73		44.0	0.113	2		walls with post 40/40mm, transparent safety glass
	1200	40	1850	UESO74		56.0	0.169	2		walls with post 40/40mm, transparent safety glass

DESCRIPTION



- NET WEIGHT

VOLUME





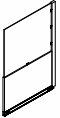

NUMBER OF PACKAGES

PRODUCT ILLUSTRATION	DIMENSIONS [mm]			INDEX SYMBOL						COMMENTS
	WIDTH	DEPTH	HEIGHT			kg	m3	pcs		

PARTITION WALLS WITH GLASS CUBIC

	640	40	1850	UESO82		40.0	0.089	2		walls with post 80/40mm, transparent safety glass
	840	40	1850	UESO83		46.0	0.117	2		walls with post 80/40mm, transparent safety glass
	1240	40	1850	UESO84		58.0	0.173	2		walls with post 80/40mm, transparent safety glass

METAL POSTS FOR FABRIC PARTITIONS

	40	40	1100	EE43		3.0	0.003	1		
	40	80	1100	EE44		3.5	0.005	1		
	40	40	1400	EE45		3.8	0.003	1		
	40	80	1400	EE46		5.5	0.006	1		
	40	40	1850	EE411		4.5	0.005	1		
	40	80	1850	EE421		6.6	0.008	1		

DESCRIPTION

 - NET WEIGHT

 VOLUME

 NUMBER OF PACKAGES

PRODUCT ILLUSTRATION	DIMENSIONS [mm]			INDEX SYMBOL						COMMENTS
	WIDTH	DEPTH	HEIGHT			kg	m3	pcs		

COMPLEMENTARY ELEMENTS

	800	390	430	J21		16.0	0.155	1		overhead storage for partition walls; 26-aluminum satinato; 67-white pastel or 154-anthracite
	1200	390	430	J22		21.7	0.230	1		overhead storage for partition walls; 26-aluminum satinato; 67-white pastel or 154-anthracite
	800	390	430	J27		17.3	0.155	1		overhead storage for partition walls; 26-aluminum satinato; 67-white pastel or 154-anthracite

DESCRIPTION

- NET WEIGHT

VOLUME

NUMBER OF PACKAGES