

TECHNICAL SPECIFICATION

COLOURS

COUNTER TOP - GLASS



GLASS LACOBEL,  
WHITE



FRONT HPL



73 HIGH GLOSS  
WHITE



74 HIGH GLOSS  
ORANGE



80 HIGH GLOSS  
LIME



81 HIGH GLOSS  
BURGUNDY

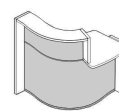
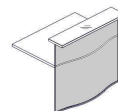

BODY



67 WHITE PASTEL

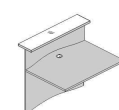
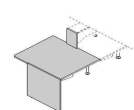

SUPPORTING LEG WHERE WORKTOPS CONNECT NL41



15 HIGH GLOSS  
WHITE

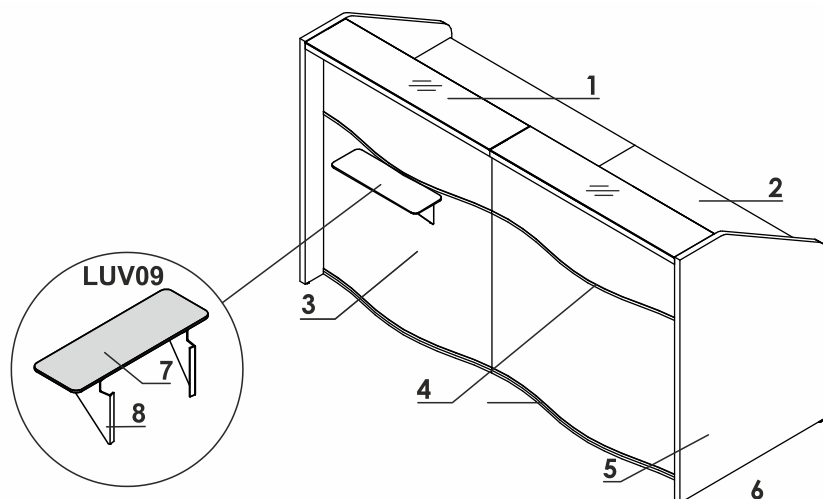

1. **Top** - MFC 28mm + Glass LACOBEL 4mm (32mm)
2. **Work top** - MFC 28mm, PVC edge
3. **Front** - HPL - high gloss
4. **Decorative stripe** - PVC, colour 09-aluminum
5. **Low side panel** - MFC 28mm, PVC edge
6. **Leveling** - 10mm range
7. **Shelf for reception counter**, HPL mat 6mm
8. **Fixing element** - powder coated metal, color 15 white gloss

TECHNICAL SPECIFICATION

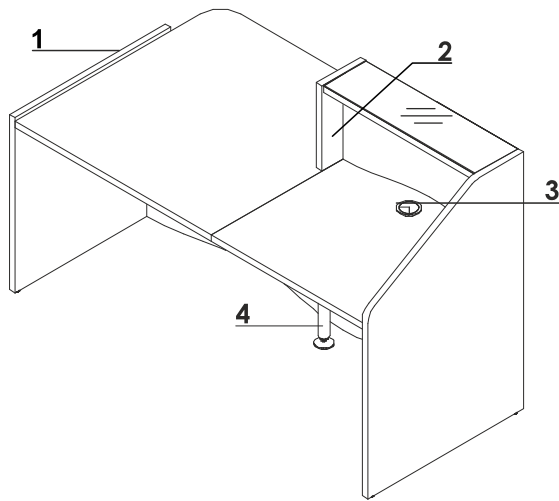

- 1. Low side panel - MFC 28mm, PVC edge
- 2. Side panel linking low and high fronts - MFC 28mm, PVC edge
- 3. Cable grommets - Ø80
- 4. Supporting leg NE41- required for connecting the tops

ATTENTION - Interior of the front in white

ENDING ELEMENTS APPLICATION

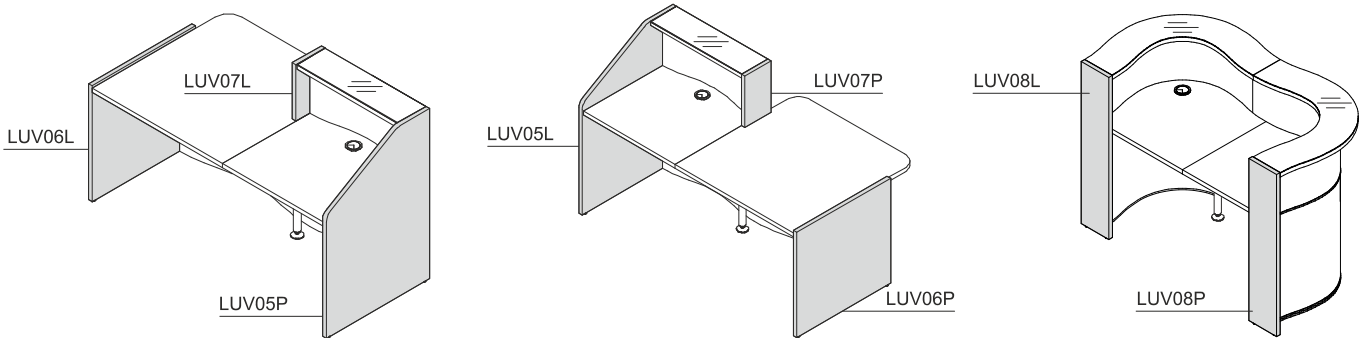

DIMENSIONS

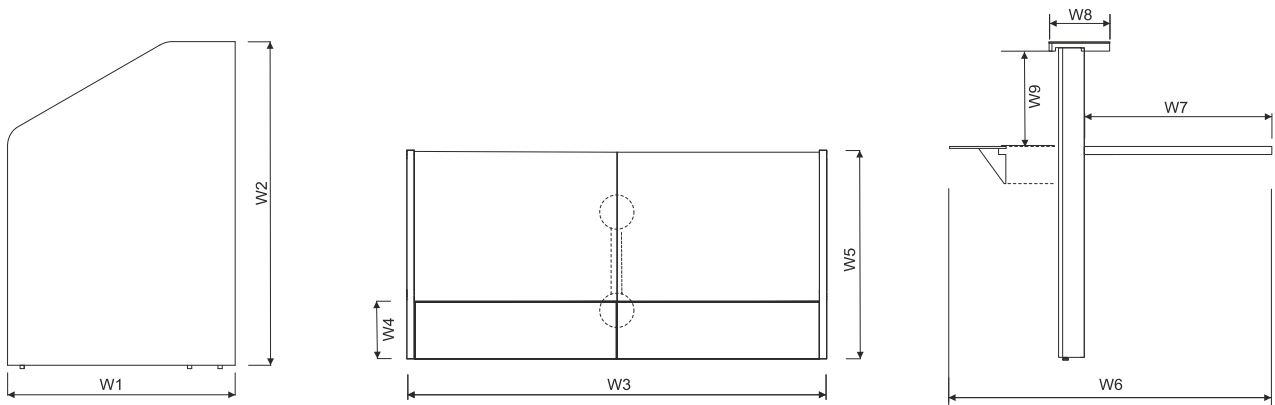

W1 - 770mm | W2 - 1103mm | W3 - 1556mm | W4 - 210mm | W5 - 770mm | W6 - 788mm | W7 - 650mm | W8 - 210mm | W9 - 330mm

RECEPTION DESKS SYSTEMS

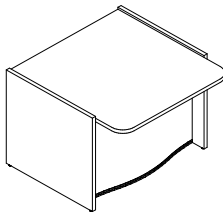

LUV10: LUV06L + LUV01 + LUV06P

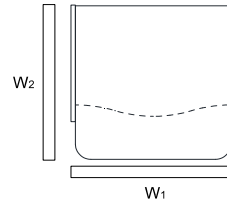

INDEX SYMBOL	DIMENSIONS [mm]						⚖️	📦	📦		COMMENTS
	W <sub>1</sub>	W <sub>2</sub>	D <sub>1</sub>	D <sub>2</sub>	H						
<b>LUV10</b>	1026	1119	-	-	755		50.0	0.167	4		

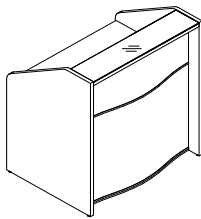

LUV11: LUV05L + LUV03<sup>02</sup> + LUV05P

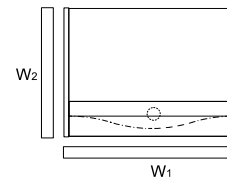

INDEX SYMBOL	DIMENSIONS [mm]						⚖️	📦	📦		COMMENTS
	W <sub>1</sub>	W <sub>2</sub>	D <sub>1</sub>	D <sub>2</sub>	H						
<b>LUV11</b>	806	770	-	-	1103		59.0	0.189	4		
<b>LUV12</b>	1026	770	-	-	1103		63.0	0.226	4		

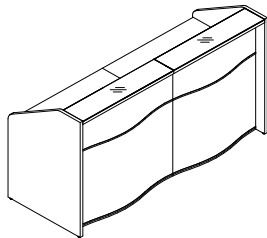

LUV05L + 2xLUV03<sup>02</sup> + LUV05P+NL41

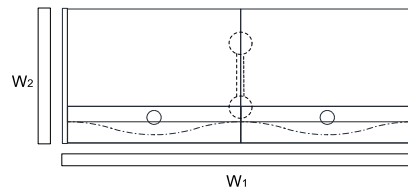

INDEX SYMBOL	DIMENSIONS [mm]						⚖️	📦	📦		COMMENTS
	W <sub>1</sub>	W <sub>2</sub>	D <sub>1</sub>	D <sub>2</sub>	H						
<b>LUV13</b>	1556	770	-	-	1103		90.0	0.380	7		
<b>LUV14</b>	1996	770	-	-	1103		98.0	0.453	7		

DESCRIPTION

⚖️ NET WEIGHT

📦 VOLUME

📦 NUMBER OF PACKAGES

RECEPTION DESKS SYSTEMS

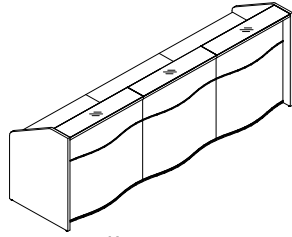

LUV05L + 3xLUV03<sup>02</sup> + LUV05P+2xNL41

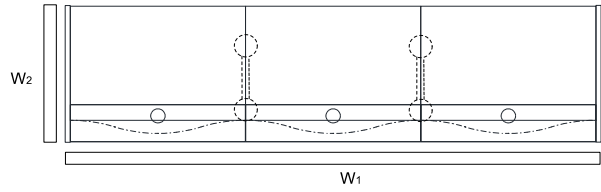

INDEX SYMBOL	DIMENSIONS [mm]						⚖️ kg	📦 m3	📦 pcs	COMMENTS
	W <sub>1</sub>	W <sub>2</sub>	D <sub>1</sub>	D <sub>2</sub>	H					
LUV15	2306	770	-	-	1103		121.0	0.570	10	
LUV16	2966	770	-	-	1103		133.0	0.681	10	

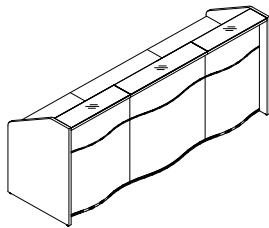

LUV05L + LUV03<sup>02</sup> + 2xLUV02<sup>03</sup> + LUV05P+2xNL41

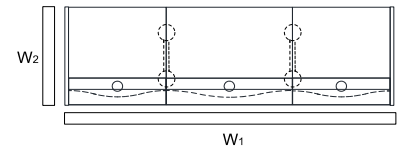
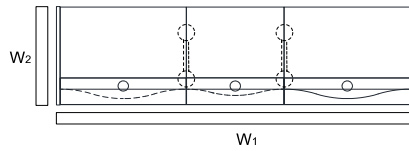

INDEX SYMBOL	DIMENSIONS [mm]						⚖️ kg	📦 m3	📦 pcs	COMMENTS
	W <sub>1</sub>	W <sub>2</sub>	D <sub>1</sub>	D <sub>2</sub>	H					
LUV17	2746	770	-	-	1103		129.0	0.644	10	
LUV18	2526	770	-	-	1103		125.0	0.607	10	

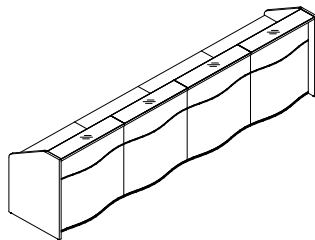

LUV05L + 4xLUV03<sup>02</sup> + LUV05P+3xNL41

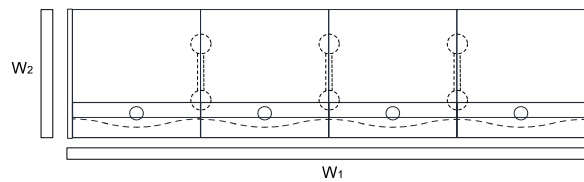

INDEX SYMBOL	DIMENSIONS [mm]						⚖️ kg	📦 m3	📦 pcs	COMMENTS
	W <sub>1</sub>	W <sub>2</sub>	D <sub>1</sub>	D <sub>2</sub>	H					
LUV19	3496	770	-	-	1103		152.0	0.761	13	
LUV20	3936	770	-	-	1103		168.0	0.909	13	

DESCRIPTION

⚖️ NET WEIGHT

📦 VOLUME

📦 NUMBER OF PACKAGES

RECEPTION DESKS SYSTEMS

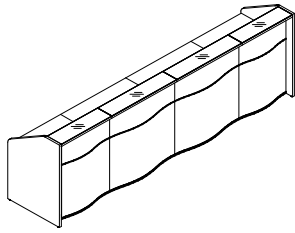

LUV05L + 2xLUV02 + 2xLUV03 + LUV05P+3xNL41

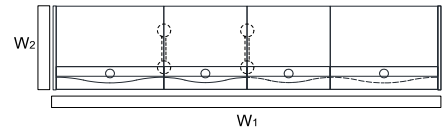
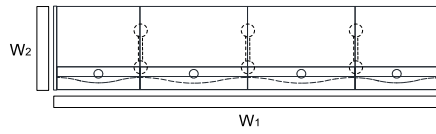

INDEX SYMBOL	DIMENSIONS					[mm]	⚖️	📦	📦	COMMENTS
	W <sub>1</sub>	W <sub>2</sub>	D <sub>1</sub>	D <sub>2</sub>	H					
<b>LUV21</b>	3496	770	-	-	1103		160.0	0.835	13	

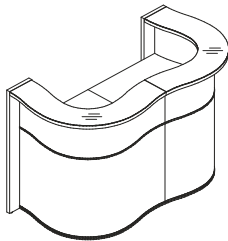

LUV08L + 2xLUV04 + LUV08P

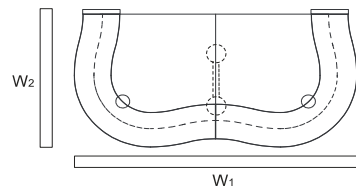

INDEX SYMBOL	DIMENSIONS					[mm]	⚖️	📦	📦	COMMENTS
	W <sub>1</sub>	W <sub>2</sub>	D <sub>1</sub>	D <sub>2</sub>	H					
<b>LUV22</b>	1624	841	-	-	1103		84.0	0.575	7	

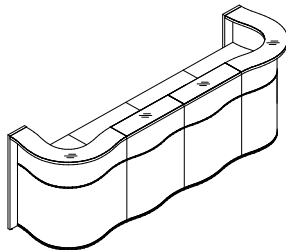

LUV08L + 2xLUV04 + 2xLUV03<sup>02</sup> + LUV08P+3xNL41

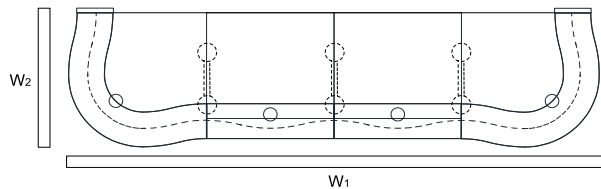

INDEX SYMBOL	DIMENSIONS					[mm]	⚖️	📦	📦	COMMENTS
	W <sub>1</sub>	W <sub>2</sub>	D <sub>1</sub>	D <sub>2</sub>	H					
<b>LUV23</b>	3124	841	-	-	1103		146.0	0.957	13	
<b>LUV24</b>	3564	841	-	-	1103		154.0	1.031	13	

DESCRIPTION

⚖️ NET WEIGHT

📦 VOLUME

📦 NUMBER OF PACKAGES

RECEPTION DESKS SYSTEMS

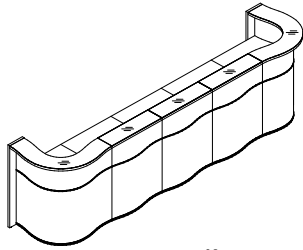

LUV08L + 2xLUV04 + 3xLUV03<sup>02</sup> + LUV08P+4xNL41

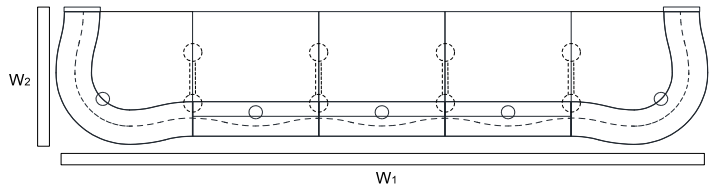

INDEX SYMBOL	DIMENSIONS [mm]						⚖️	📦	📦		COMMENTS
	W <sub>1</sub>	W <sub>2</sub>	D <sub>1</sub>	D <sub>2</sub>	H						
LUV25	3874	841	-	-	1103		177.0	1.148	16		
LUV26	4534	841	-	-	1103		189.0	1.259	16		

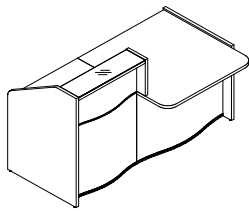

A: LUV05L + LUV03<sup>02</sup> + LUV07P + LUV01 + LUV06P+NL41  
 B: LUV06L + LUV01 + LUV07L + LUV03<sup>02</sup> + LUV05P+NL41

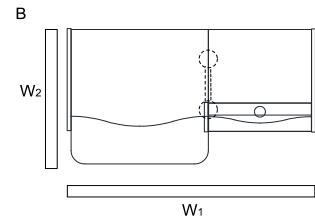
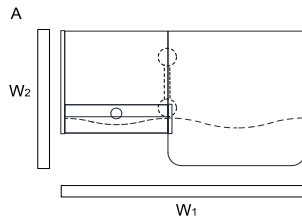

INDEX SYMBOL		DIMENSIONS [mm]						⚖️	📦	📦		COMMENTS
A	B	W <sub>1</sub>	W <sub>2</sub>	D <sub>1</sub>	D <sub>2</sub>	H						
LUV27L	LUV27P	1776	1019	-	-	1103		87.0	0.368	8		
LUV28L	LUV28P	1996	1019	-	-	1103		91.0	0.405	8		

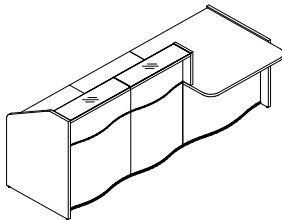

A: LUV05L + 2xLUV03<sup>02</sup> + LUV07P + LUV01 + LUV06P+2xNL41  
 B: LUV06L + LUV01 + LUV07L + 2xLUV03<sup>02</sup> + LUV05P+2xNL41

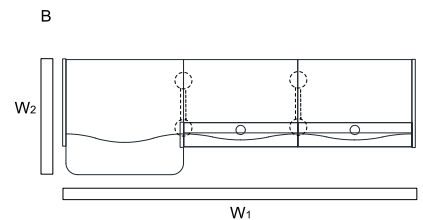
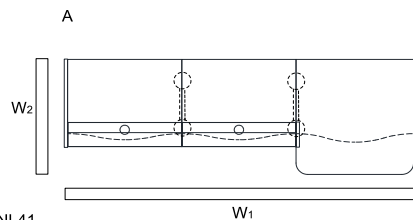

INDEX SYMBOL		DIMENSIONS [mm]						⚖️	📦	📦		COMMENTS
A	B	W <sub>1</sub>	W <sub>2</sub>	D <sub>1</sub>	D <sub>2</sub>	H						
LUV29L	LUV29P	2526	1019	-	-	1103		118.0	0.559	11		
LUV30L	LUV30P	2966	1019	-	-	1103		126.0	0.633	11		

DESCRIPTION

⚖️ NET WEIGHT

📦 VOLUME

📦 NUMBER OF PACKAGES

RECEPTION DESKS SYSTEMS

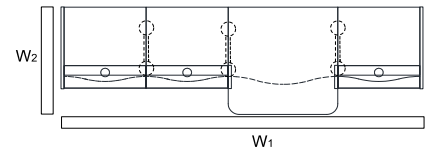
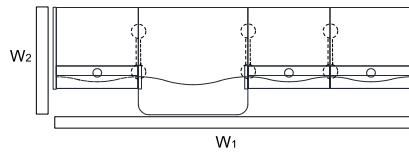
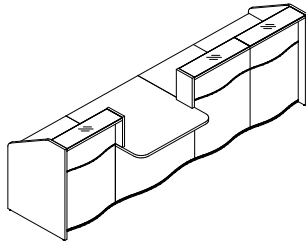

LUV05L + 2xLUV03<sup>02</sup> + LUV07P + LUV01 + LUV07L + LUV03<sup>02</sup> + LUV05P+3xNL41

INDEX SYMBOL	DIMENSIONS [mm]									COMMENTS
	W <sub>1</sub>	W <sub>2</sub>	D <sub>1</sub>	D <sub>2</sub>	H		kg	m <sup>3</sup>	pcs	
LUV31	3276	1019	-	-	1103		155.0	0.759	15	
LUV32	3936	1019	-	-	1103		167.0	0.870	15	

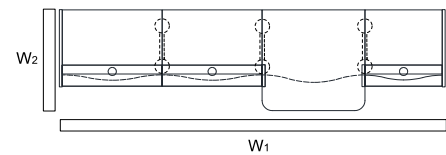
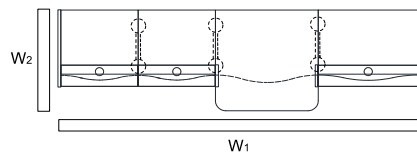
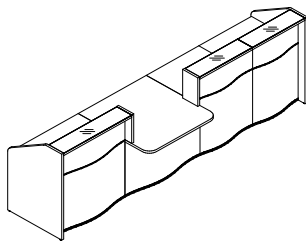

LUV5L + LUV02<sup>03</sup> + LUV07P + LUV01 + LUV07L + 2xLUV03<sup>02</sup> + LUV05P+3xNL41

INDEX SYMBOL	DIMENSIONS [mm]									COMMENTS
	W <sub>1</sub>	W <sub>2</sub>	D <sub>1</sub>	D <sub>2</sub>	H		kg	m <sup>3</sup>	pcs	
LUV33	3496	1019	-	-	1103		159.0	0.796	15	
LUV34	3716	1019	-	-	1103		163.0	0.833	15	

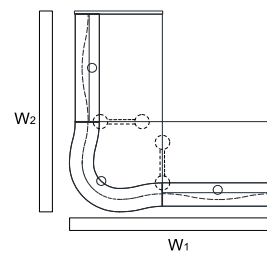
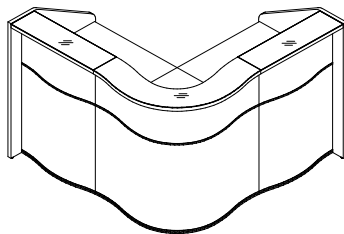

LUV5L + LUV03<sup>02</sup> + LUV04 + LUV03<sup>02</sup> + LUV05P+2xNL41

INDEX SYMBOL	DIMENSIONS [mm]									COMMENTS
	W <sub>1</sub>	W <sub>2</sub>	D <sub>1</sub>	D <sub>2</sub>	H		kg	m <sup>3</sup>	pcs	
LUV35	1590	1590	-	-	1103		128.0	0.689	10	
LUV36	1810	1810	-	-	1103		136.0	0.763	10	

DESCRIPTION

NET WEIGHT

VOLUME

NUMBER OF PACKAGES

RECEPTION DESKS SYSTEMS

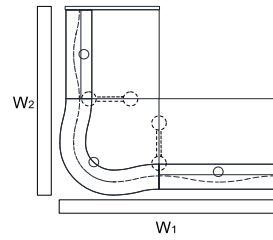
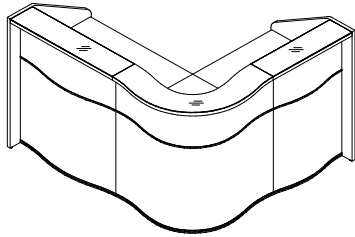

LUV05L + LUV03 + LUV04 + LUV02 + LUV05P+2xNL41

INDEX SYMBOL	DIMENSIONS					[mm]		⚖️	📦	📦		COMMENTS
	W <sub>1</sub>	W <sub>2</sub>	D <sub>1</sub>	D <sub>2</sub>	H							
<b>LUV37</b>	1810	1590	-	-	1103			132.0	0.726	10		

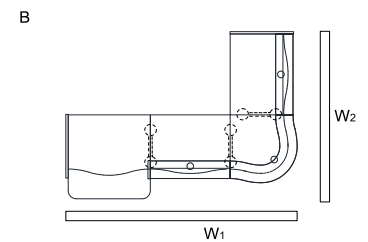
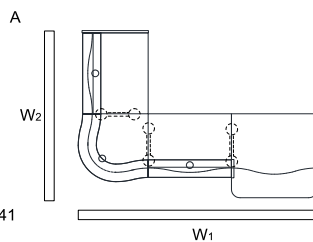
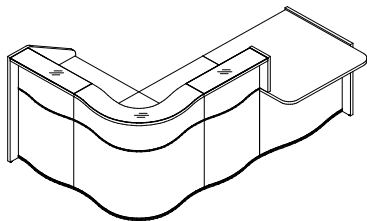

A: LUV06L + LUV01 + LUV07L + LUV03<sup>02</sup> + LUV04 + LUV03<sup>02</sup> + LUV05P+3xNL41

B: LUV05L + LUV03<sup>02</sup> + LUV04 + LUV03<sup>02</sup> + LUV07P + LUV01 + LUV06P+3xNL41

INDEX SYMBOL		DIMENSIONS					[mm]		⚖️	📦	📦		COMMENTS
A	B	W <sub>1</sub>	W <sub>2</sub>	D <sub>1</sub>	D <sub>2</sub>	H							
<b>LUV38L</b>	<b>LUV38P</b>	2560	1590	-	-	1103		156.0	0.868	14			
<b>LUV39L</b>	<b>LUV39P</b>	2780	1810	-	-	1103		164.0	0.942	14			

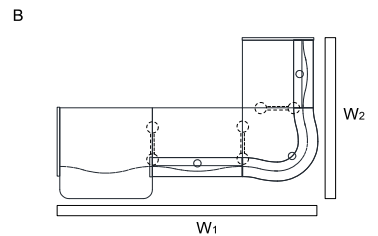
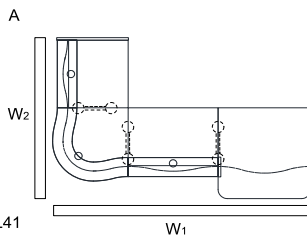
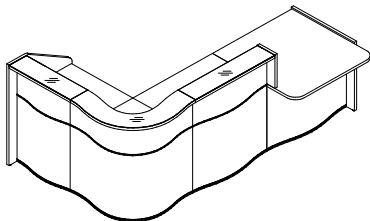

A: LUV06L + LUV01 + LUV07L + LUV03 + LUV04 + LUV02 + LUV05P+3xNL41

B: LUV05L + LUV02 + LUV04 + LUV03 + LUV07P + LUV01 + LUV06P+3xNL41

INDEX SYMBOL		DIMENSIONS					[mm]		⚖️	📦	📦		COMMENTS
A	B	W <sub>1</sub>	W <sub>2</sub>	D <sub>1</sub>	D <sub>2</sub>	H							
<b>LUV40L</b>	<b>LUV40P</b>	2780	1792	-	-	1103		160.0	0.905	14			

DESCRIPTION

⚖️ NET WEIGHT

📦 VOLUME

📦 NUMBER OF PACKAGES



RECEPTION DESKS SYSTEMS

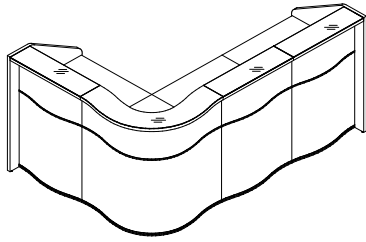

LUV05L + 2xLUV03<sup>02</sup> + LUV04 + LUV03<sup>02</sup> + LUV05P+3xNL41

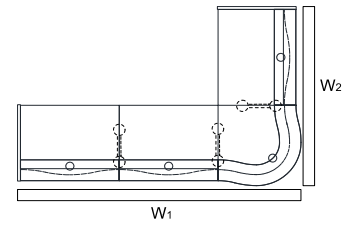
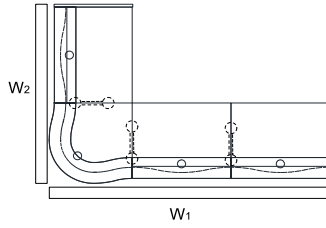

INDEX SYMBOL	DIMENSIONS [mm]						⚖️	📦	📦		COMMENTS
	W <sub>1</sub>	W <sub>2</sub>	D <sub>1</sub>	D <sub>2</sub>	H						
LUV41	2340	1590	-	-	1103		159.0	0.879	13		
LUV42	2780	1810	-	-	1103		171.0	0.990	13		

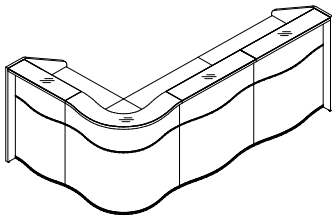

LUV05L + LUV03<sup>02</sup> + LUV04 + 2xLUV02<sup>03</sup> + LUV05P+3xNL41

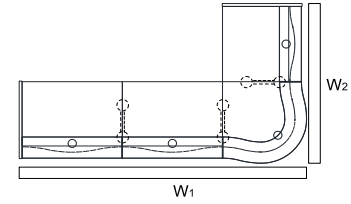
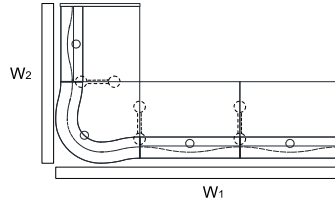

INDEX SYMBOL	DIMENSIONS [mm]						⚖️	📦	📦		COMMENTS
	W <sub>1</sub>	W <sub>2</sub>	D <sub>1</sub>	D <sub>2</sub>	H						
LUV43	2780	1792	-	-	1103		167.0	0.953	13		
LUV44	2343	1813	-	-	1103		163.0	0.916	13		

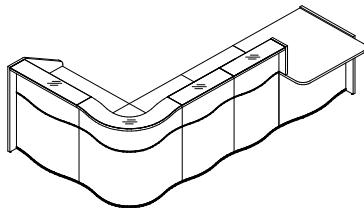

A: LUV06L + LUV01 + LUV07L + 2xLUV03<sup>02</sup> + LUV04 + LUV03<sup>02</sup> + LUV05P+4xNL41  
 B: LUV05L + LUV03<sup>02</sup> + LUV04 + 2xLUV03<sup>02</sup> + LUV07P + LUV01 + LUV06P+4xNL41

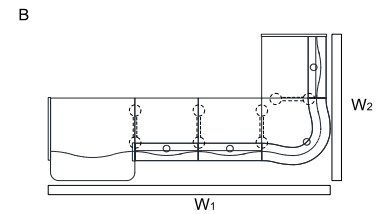
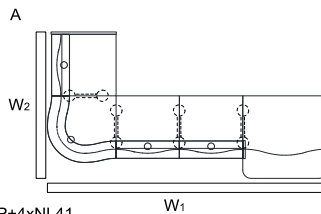

INDEX SYMBOL		DIMENSIONS [mm]						⚖️	📦	📦		COMMENTS
A	B	W <sub>1</sub>	W <sub>2</sub>	D <sub>1</sub>	D <sub>2</sub>	H						
LUV45L	LUV45P	3310	1792	-	-	1103		187.0	1.059	17		
LUV46L	LUV46P	3750	1810	-	-	1103		199.0	1.169	17		

DESCRIPTION

⚖️ NET WEIGHT

📦 VOLUME

📦 NUMBER OF PACKAGES

RECEPTION DESKS SYSTEMS

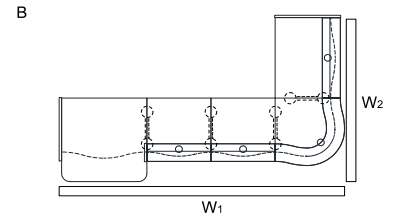
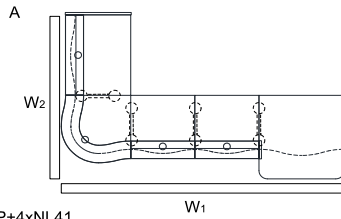
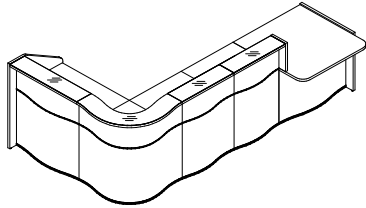

A: LUV06L + LUV01 + LUV07L + 2xLUV03<sup>02</sup> + LUV04 + LUV02<sup>03</sup> + LUV05P+4xNL41  
 B: LUV05L + LUV02<sup>03</sup> + LUV04 + 2xLUV03<sup>02</sup> + LUV07P + LUV01 + LUV06P+4xNL41

INDEX SYMBOL		DIMENSIONS [mm]						⚖️	📦	📦		COMMENTS
A	B	W <sub>1</sub>	W <sub>2</sub>	D <sub>1</sub>	D <sub>2</sub>	H						
LUV47L	LUV47P	3310	1810	-	-	1103	195.0	1.133	17			
LUV48L	LUV48P	3750	1792	-	-	1103	191.0	1.096	17			

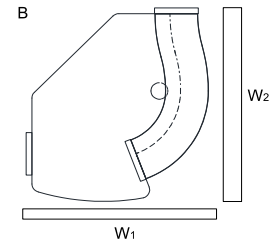
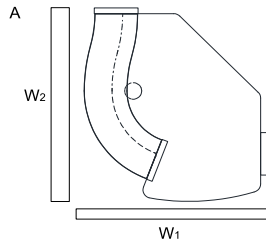
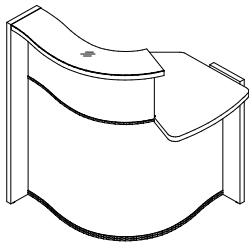



INDEX SYMBOL		DIMENSIONS [mm]						⚖️	📦	📦		COMMENTS
A	B	W <sub>1</sub>	W <sub>2</sub>	D <sub>1</sub>	D <sub>2</sub>	H						
LUV49L	LUV49P	858	925	-	-	1103	39.0	0.231	2			

DESCRIPTION



⚖️ NET WEIGHT

📦 VOLUME

📦 NUMBER OF PACKAGES

PRODUCT ILLUSTRATION	DIMENSIONS [mm]			INDEX SYMBOL						COMMENTS
	WIDTH	DEPTH	HEIGHT			kg	m3	pcs		

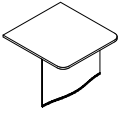
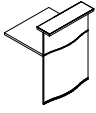
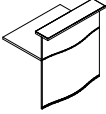
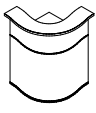
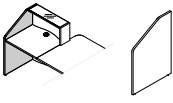
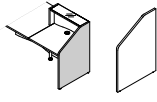
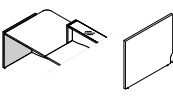
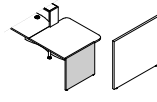
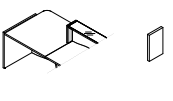
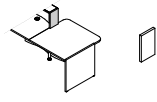
COMPOSITION ELEMENTS



	970	1015	740	LUV01		28.0	0.118	2		
	750	763	1103	LUV02		29.0	0.128	2		
	970	763	1103	LUV03		33.0	0.165	2		
	815	815	1103	LUV04		36.0	0.246	2		
	770	28	1103	LUV05L		15.0	0.030	1		left
	770	28	1103	LUV05P		15.0	0.030	1		right
	770	28	755	LUV06L		11.0	0.024	1		left
	770	28	755	LUV06P		11.0	0.024	1		right
	216	28	363	LUV07L		2.0	0.004	1		left
	216	28	363	LUV07P		2.0	0.004	1		right
	216	28	1103	LUV08L		5.0	0.010	1		left

DESCRIPTION



 NET WEIGHT

 VOLUME

 NUMBER OF PACKAGES

PRODUCT ILLUSTRATION	DIMENSIONS [mm]			INDEX SYMBOL						COMMENTS
	WIDTH	DEPTH	HEIGHT			kg	m3	pcs		

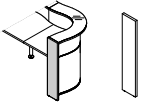
**COMPOSITION ELEMENTS**

	216	28	1103	<b>LUV08P</b>		5.0	0.010	1		right
	470	170	170	<b>LUV09</b>		0.0	0.000	0		67-white pastel
	585	142	712	<b>NL41</b>		2.0	0.063	1		round profile leg

DESCRIPTION

 NET WEIGHT

 VOLUME

 NUMBER OF PACKAGES