

TECHNICAL SPECIFICATION

COLOURS

BODY, FRONT, COUNTER TOP

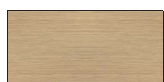

31 CANADIAN OAK



67 WHITE PASTEL

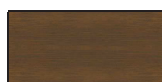

106 LOWLAND NUT

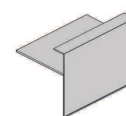
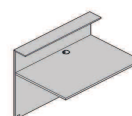

HPL ELEMENTS STRUCTURE



31 CANADIAN OAK



67 WHITE PASTEL

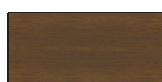

106 LOWLAND NUT

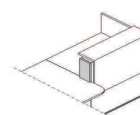
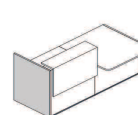

CORNER UNIT



73 HIGH GLOSS
WHITE



101 HIGH GLOSS
BLACK



155 ANTHRACITE
HIGH GLOSS

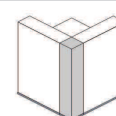

OPTIONAL TOP ELEMENT WITH LIGHT



73 HIGH GLOSS
WHITE



WHITE, LACOBEL

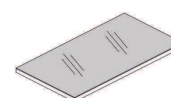
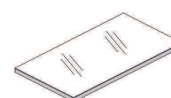

101 HIGH GLOSS
BLACK



BLACK, LACOBEL

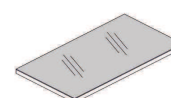
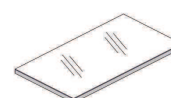

155 ANTHRACITE
HIGH GLOSS



ANTHRACITE,
LACOBEL

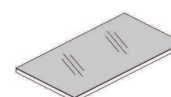
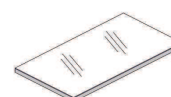

SUPPORTING LEG WHERE WORKTOPS CONNECT NL41



15 HIGH GLOSS
WHITE

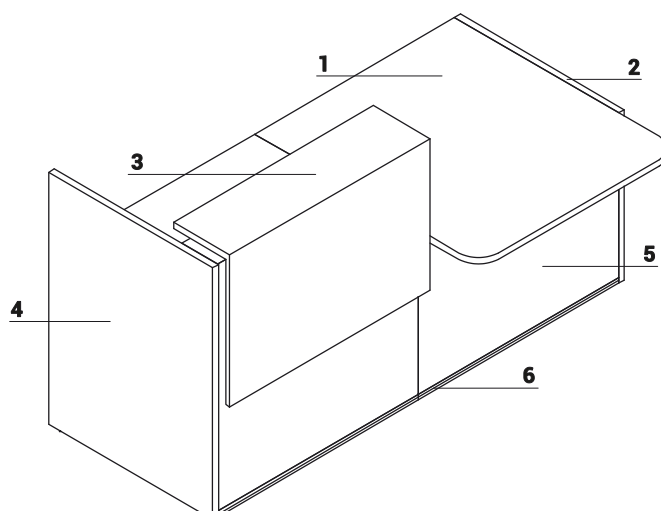

1. **Worktop** - MFC 28mm, PVC edge
2. **Low side panel** - MFC 28mm, PVC edge
3. **Optional top element with lightening** - top melamine board 28mm + Glass LACOBEL 4mm, front melamine board 18mm, all in HPL - gloss
4. **High side panel** - MFC 28mm, PVC edge
5. **Front** - MFC 18mm, PVC edge
6. **Decorative stripe** - PVC, colour 09-aluminum

TECHNICAL SPECIFICATION

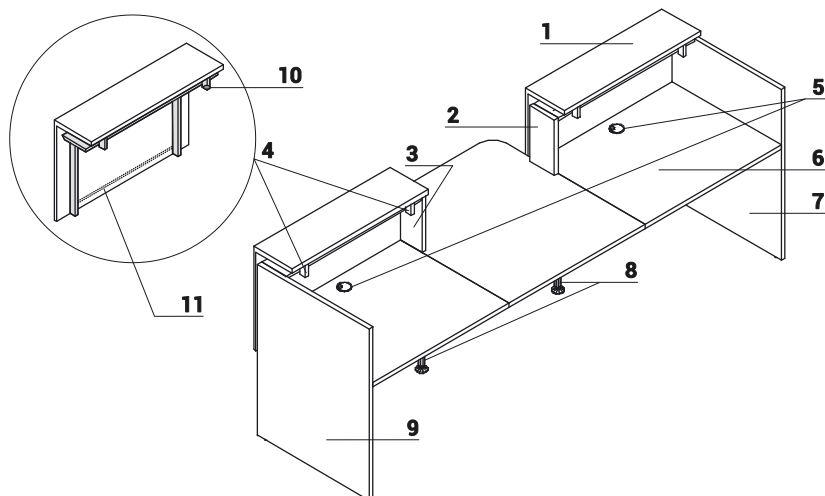

1. **Optional top element with lightening** - top melamine board 28mm + Glass LACOBEL 4mm, front melamine board 18mm, all in HPL - gloss
2. **Side panel linking low and high fronts** - MFC 28mm, PVC edge
3. **Side panel linking low and high fronts** - MFC 28mm, PVC edge
4. **Frame to optional top element with lightening** - metal powder-coated, white colour
5. **Cable grommets** - Ø80mm
6. **Worktop** - MFC 28mm, PVC edge
7. **High side panel** - MFC 28mm, PVC edge
8. **Supporting leg NL41**- required for connecting the tops
9. **High side panel** - MFC 28mm, PVC edge
10. **Light switch**
11. **LED lighting** - over the entire length of the extension, cold white (bluish kind of white)

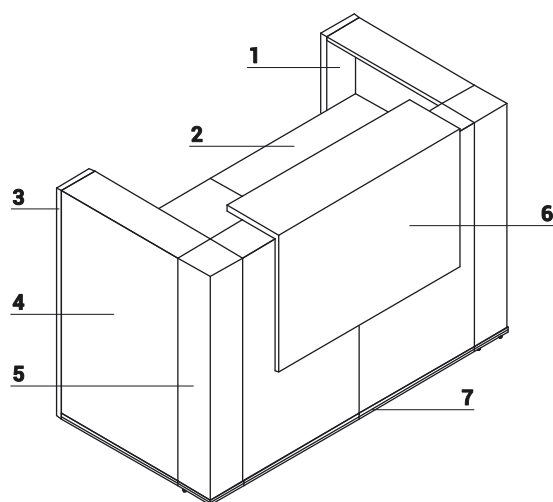

1. **High side panel** - MFC 28mm, PVC edge
2. **Worktop** - MFC 28mm, PVC edge
3. **High side panel** - MFC 28mm, PVC edge
4. **Front** - MFC 18mm, PVC edge
5. **Corner unit** - melamine board covered with HPL - gloss
6. **Optional top element with lightening** - top melamine board 28mm + Glass LACOBEL 4mm, front melamine board 18mm, all in HPL - gloss
7. **Decorative stripe** - PVC, colour 09 - aluminum

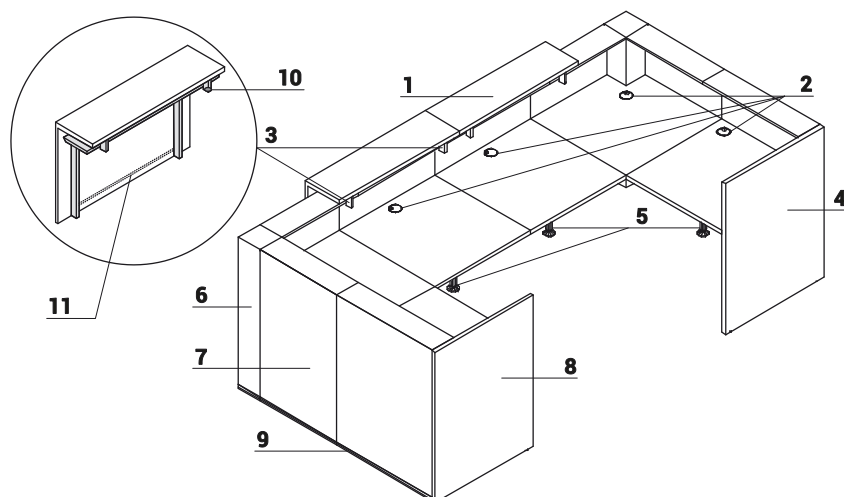

1. **Optional top element with lightening** - top melamine board 28mm + Glass LACOBEL 4mm, front melamine board 18mm, all in HPL - gloss
2. **Cable grommets** - Ø80mm
3. **Frame to optional top element with lightening** - metal powder - coated, white colour
4. **High side panel** - MFC 28mm, PVC edge
5. **Supporting leg NL41**- required for connecting the tops
6. **Corner unit** - melamine board covered with HPL - gloss
7. **Front** - MFC 18mm, PVC edge
8. **High side panel** - MFC 28mm, PVC edge
9. **Decorative stripe** - PVC, colour 09 - aluminum
10. **Light switch**
11. **LED lighting** - over the entire length of the extension, cold white (bluish kind of white)

TECHNICAL SPECIFICATION

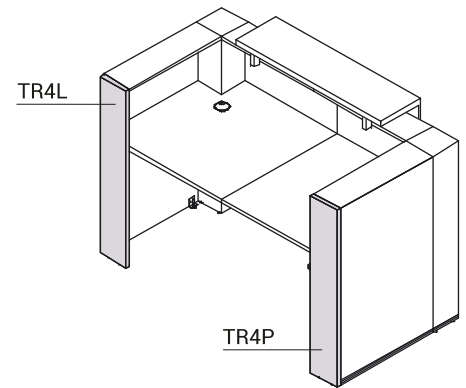
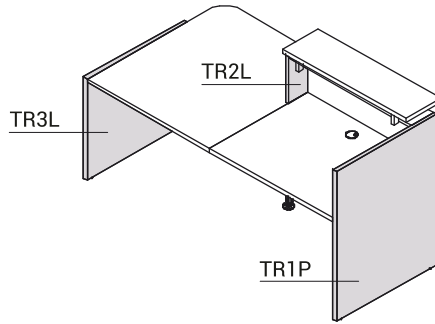
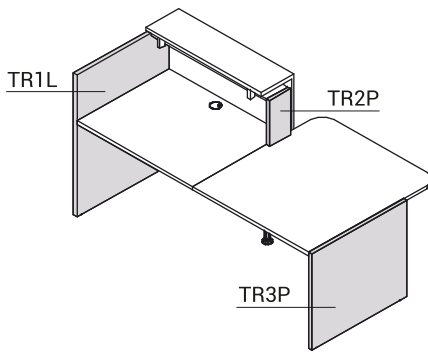

DIMENSIONS

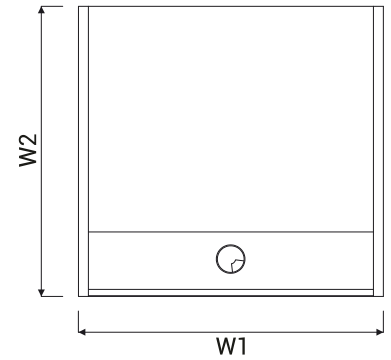
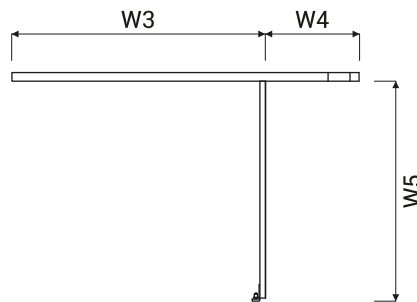
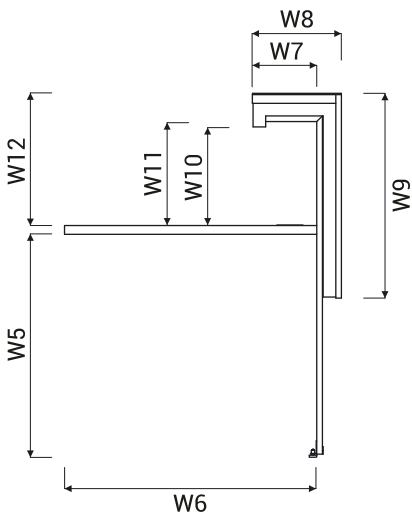

W1 - 856mm | W2 - 820mm | W3 - 818mm | W4 - 302mm | W5 - 740mm | W6 - 800mm | W7 - 205mm | W8 - 282mm | W9 - 650mm | W10 - 315mm | W11 - 322mm | W12 - 419mm

RECEPTION DESKS SYSTEMS

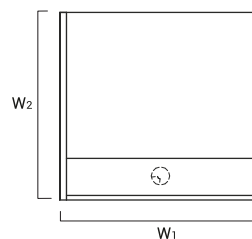
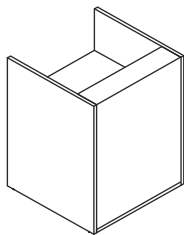

INDEX SYMBOL	DIMENSIONS [mm]									COMPONENTS
	W ₁	W ₂	D ₁	D ₂	H		kg	m ³	pcs	
TRA13	856	820	-	-	1090		59.0	0.124	3	TR1L+TR08+TR1P

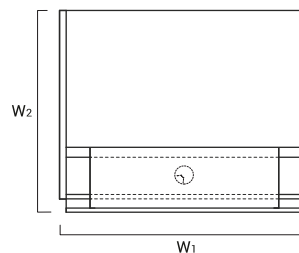
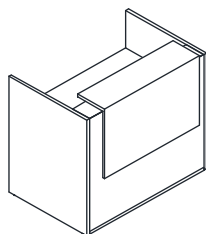

INDEX SYMBOL	DIMENSIONS [mm]									COMPONENTS
	W ₁	W ₂	D ₁	D ₂	H		kg	m ³	pcs	
TRA14	1056	877	-	-	1159		83.0	0.320	4	TR1L+TR10+TR99+TR1P
TRA15	1256	877	-	-	1159		87.0	0.332	4	TR1L+TR12+TR99+TR1P
TRA16	1456	877	-	-	1159		89.0	0.344	4	TR1L+TR14+TR99+TR1P

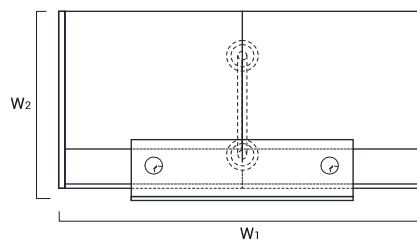
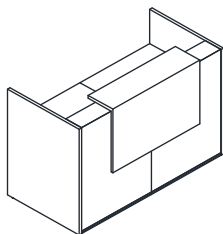

INDEX SYMBOL	DIMENSIONS [mm]									COMPONENTS
	W ₁	W ₂	D ₁	D ₂	H		kg	m ³	pcs	
TRA17	1656	877	-	-	1159		103.0	0.425	6	TR1L+2xTR08+TR99+TR1P+NL41
TRA18	2056	877	-	-	1159		117.0	0.449	6	TR1L+2xTR10+TR99+TR1P+NL41
TRA19	2456	877	-	-	1159		125.0	0.473	6	TR1L+2xTR12+TR99+TR1P+NL41
TRA20	2856	877	-	-	1159		129.0	0.498	6	TR1L+2xTR14+TR99+TR1P+NL41

DESCRIPTION

- NET WEIGHT

VOLUME

NUMBER OF PACKAGES

RECEPTION DESKS SYSTEMS

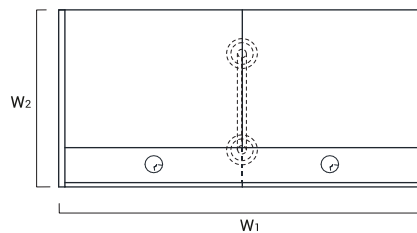
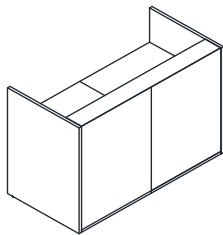

INDEX SYMBOL	DIMENSIONS [mm]									COMPONENTS
	W ₁	W ₂	D ₁	D ₂	H		kg	m ³	pcs	
TRA117	1656	820	-	-	1159		86.0	0.242	5	TR1L+2xTR08+TR1P+NL41
TRA118	2056	820	-	-	1159		100.0	0.266	5	TR1L+2xTR10+TR1P+NL41
TRA119	2456	820	-	-	1159		108.0	0.290	5	TR1L+2xTR12+TR1P+NL41
TRA120	2856	820	-	-	1159		112.0	0.314	5	TR1L+2xTR14+TR1P+NL41

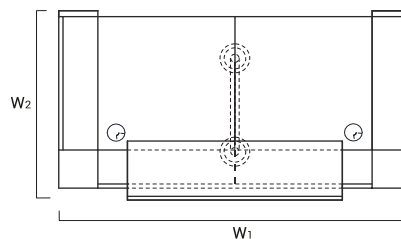
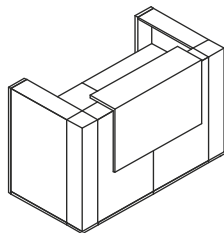

INDEX SYMBOL	DIMENSIONS [mm]									COMPONENTS
	W ₁	W ₂	D ₁	D ₂	H		kg	m ³	pcs	
TRA42	1640	905	-	-	1159		99.0	0.460	8	TR4L+2xTR90+TR4P+TR99+NL41

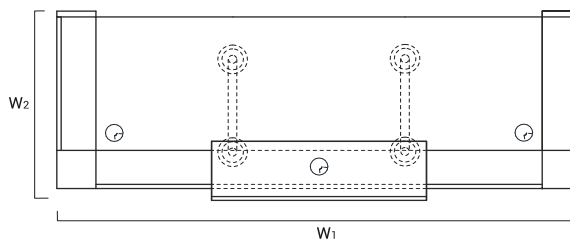
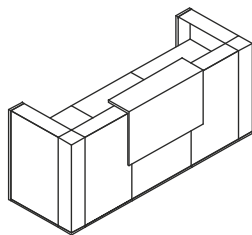

INDEX SYMBOL	DIMENSIONS [mm]									COMPONENTS
	W ₁	W ₂	D ₁	D ₂	H		kg	m ³	pcs	
TRA21	2440	905	-	-	1159		126.0	0.577	10	TR4L+2xTR90+TR08+TR4P+TR99+2xNL41
TRA22	2640	905	-	-	1159		133.0	0.590	10	TR4L+2xTR90+TR10+TR4P+TR99+2xNL41
TRA23	2840	905	-	-	1159		137.0	0.602	10	TR4L+2xTR90+TR12+TR4P+TR99+2xNL41
TRA24	3040	905	-	-	1159		139.0	0.614	10	TR4L+2xTR90+TR14+TR4P+TR99+2xNL41

DESCRIPTION

- NET WEIGHT

VOLUME

NUMBER OF PACKAGES

RECEPTION DESKS SYSTEMS

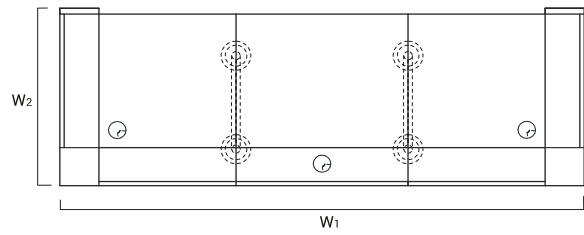
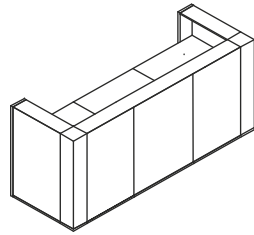

INDEX SYMBOL	DIMENSIONS [mm]										COMPONENTS
	W ₁	W ₂	D ₁	D ₂	H						
TRA121	2440	848	-	-	1159		109.0	0.394	9		TR4L+2xTR90+TR08+TR4P +2xNL41
TRA122	2640	848	-	-	1159		116.0	0.406	9		TR4L+2xTR90+TR10+TR4P +2xNL41
TRA123	2840	848	-	-	1159		120.0	0.418	9		TR4L+2xTR90+TR12+TR4P +2xNL41
TRA124	3040	848	-	-	1159		122.0	0.430	9		TR4L+2xTR90+TR14+TR4P +2xNL41

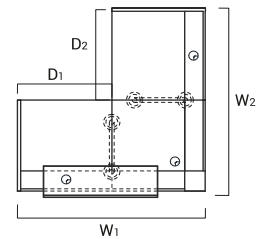
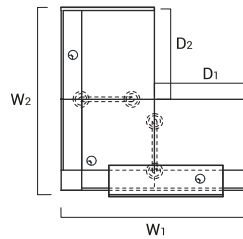
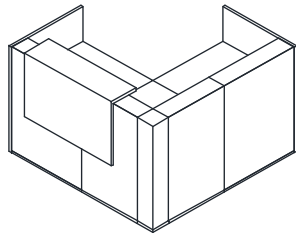

INDEX SYMBOL	DIMENSIONS [mm]										COMPONENTS
	W ₁	W ₂	D ₁	D ₂	H						
TRA25	1648	1705	-	-	1159		141.0	0.586	9		TR1L+TR08+TR90+TR08+TR1P +TR99+2xNL41
TRA26	1848	1705	-	-	1159		148.0	0.598	9		TR1L+TR08+TR90+TR10+TR1P +TR99+2xNL41
TRA27	2048	1705	-	-	1159		152.0	0.611	9		TR1L+TR08+TR90+TR12+TR1P +TR99+2xNL41
TRA28	2248	1705	-	-	1159		154.0	0.623	9		TR1L+TR08+TR90+TR14+TR1P +TR99+2xNL41

DESCRIPTION

- NET WEIGHT

VOLUME

NUMBER OF PACKAGES

RECEPTION DESKS SYSTEMS

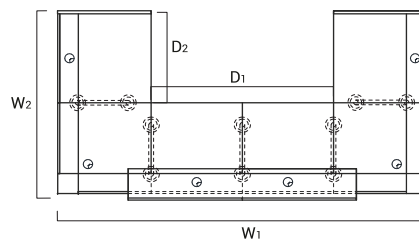
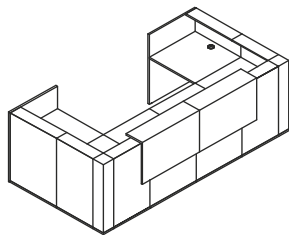

INDEX SYMBOL	DIMENSIONS [mm]					kg	m3	pcs	COMPONENTS
	W ₁	W ₂	D ₁	D ₂	H				
TRA29	3240	1705	-	-	1159	250.0	1.166	17	TR1L+2xTR08+2xTR90+2xTR08 +TR1P+2xTR99+5xNL41
TRA30	3640	1705	-	-	1159	264.0	1.190	17	TR1L+2xTR08+2xTR90+2xTR10 +TR1P+2xTR99+5xNL41
TRA31	4040	1705	-	-	1159	272.0	1.214	17	TR1L+2xTR08+2xTR90+2xTR12 +TR1P+2xTR99+5xNL41
TRA32	4440	1705	-	-	1159	276.0	1.239	17	TR1L+2xTR08+2xTR90+2xTR14 +TR1P+2xTR99+5xNL41

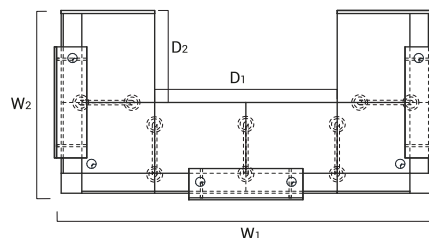
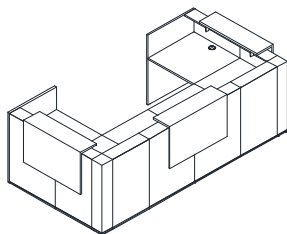

INDEX SYMBOL	DIMENSIONS [mm]					kg	m3	pcs	COMPONENTS
	W ₁	W ₂	D ₁	D ₂	H				
TRA129	3354	1705	-	-	1159	267.0	1.349	18	TR1L+2xTR08+2xTR90+2xTR08 +TR1P+3xTR99+5xNL41
TRA130	3754	1705	-	-	1159	281.0	1.374	18	TR1L+2xTR08+2xTR90+2xTR10 +TR1P+3xTR99+5xNL41
TRA131	4154	1705	-	-	1159	289.0	1.398	18	TR1L+2xTR08+2xTR90+2xTR12 +TR1P+3xTR99+5xNL41
TRA132	4554	1705	-	-	1159	293.0	1.422	18	TR1L+2xTR08+2xTR90+2xTR14 +TR1P+3xTR99+5xNL41

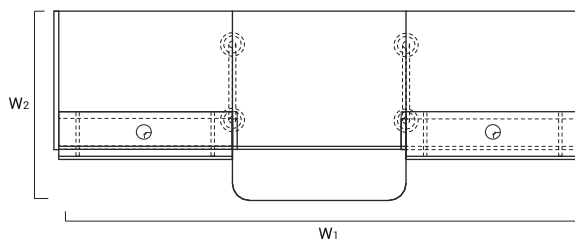
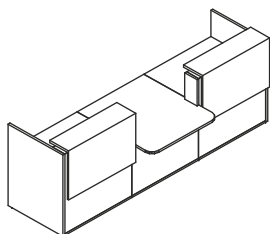

INDEX SYMBOL	DIMENSIONS [mm]					kg	m3	pcs	COMPONENTS
	W ₁	W ₂	D ₁	D ₂	H				
TRA33	3056	1120	-	-	1159	169.0	0.793	11	TR1L+TR10+TR2P+TR11+TR2L +TR10+TR1P+2xTR99+2xNL41
TRA34	3456	1120	-	-	1159	177.0	0.817	11	TR1L+TR12+TR2P+TR11+TR2L +TR12+TR1P+2xTR99+2xNL41
TRA35	3856	1120	-	-	1159	181.0	0.841	11	TR1L+TR14+TR2P+TR11+TR2L +TR14+TR1P+2xTR99+2xNL41

DESCRIPTION

- NET WEIGHT

VOLUME

NUMBER OF PACKAGES

RECEPTION DESKS SYSTEMS

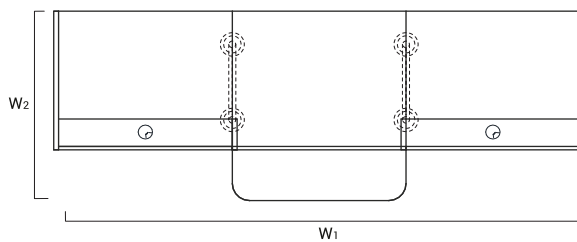
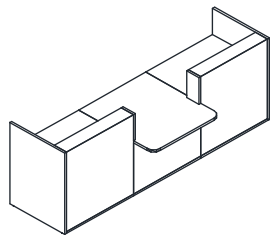

INDEX SYMBOL	DIMENSIONS [mm]						⚖️ kg	📦 m3	📦 pcs		COMPONENTS
	W ₁	W ₂	D ₁	D ₂	H						
TRA133	3056	1120	-	-	1159		135.0	0.426	9		TR12+TR10+TR2P+TR11+TR2L +TR10+TR1P+2xNL41
TRA134	3456	1120	-	-	1159		143.0	0.451	9		TR12+TR12+TR2P+TR11+TR2L +TR12+TR1P+2xNL41
TRA135	3856	1120	-	-	1159		147.0	0.475	9		TR12+TR14+TR2P+TR11+TR2L +TR14+TR1P+2xNL41

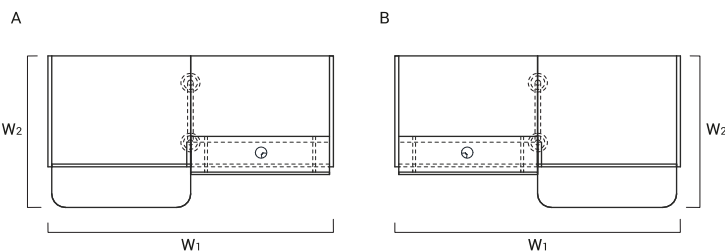
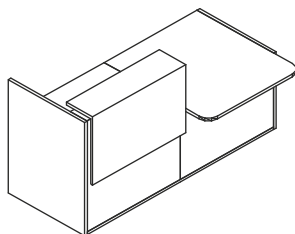

INDEX SYMBOL	DIMENSIONS [mm]						⚖️ kg	📦 m3	📦 pcs		COMPONENTS
	W ₁	W ₂	D ₁	D ₂	H						
A TRA36L	2056	1120	-	-	1159		111.5	0.467	7		TR1L+TR10+TR2P+TR11+TR3P +TR99+NL41
B TRA36P	2056	1120	-	-	1159		111.5	0.467	7		TR3L+TR11+TR2L+TR10+TR1P +TR99+NL41
A TRA37L	2256	1120	-	-	1159		115.5	0.479	7		TR1L+TR12+TR2P+TR11+TR3P +TR99+NL41
B TRA37P	2256	1120	-	-	1159		115.5	0.479	7		TR3L+TR11+TR2L+TR12+TR1P +TR99+NL41
A TRA38L	2456	1120	-	-	1159		117.5	0.491	7		TR1L+TR14+TR2P+TR11+TR3P +TR99+NL41
B TRA38P	2456	1120	-	-	1159		117.5	0.492	7		TR3L+TR11+TR2L+TR14+TR1P +TR99+NL41

DESCRIPTION

⚖️ - NET WEIGHT

📦 VOLUME

📦 NUMBER OF PACKAGES

RECEPTION DESKS SYSTEMS

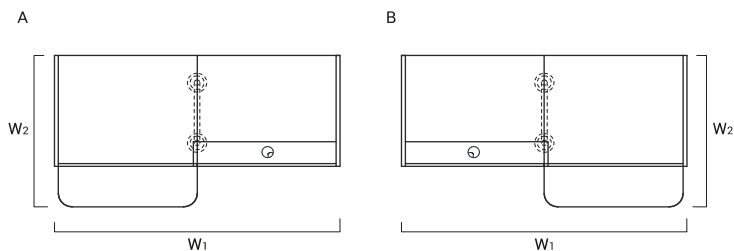
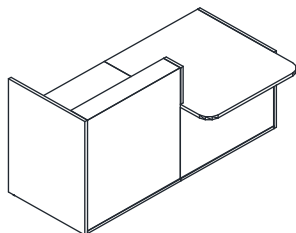

INDEX SYMBOL	DIMENSIONS [mm]						kg	m3	pcs	COMPONENTS
	W ₁	W ₂	D ₁	D ₂	H					
A TRA136L	2056	1120	-	-	1159		94.5	0.283	6	TR1L+TR10+TR2P+TR11+TR3P+NL41
B TRA136P	2056	1120	-	-	1159		94.5	0.284	6	TR3L+TR11+TR2L+TR10+TR1P+NL41
A TRA137L	2256	1120	-	-	1159		98.5	0.295	6	TR1L+TR12+TR2P+TR11+TR3P+NL41
B TRA137P	2256	1120	-	-	1159		98.5	0.296	6	TR3L+TR11+TR2L+TR12+TR1P+NL41
A TRA138L	2456	1120	-	-	1159		100.5	0.308	6	TR1L+TR14+TR2P+TR11+TR3P+NL41
B TRA138P	2456	1120	-	-	1159		100.5	0.308	6	TR3L+TR11+TR2L+TR14+TR1P+NL41

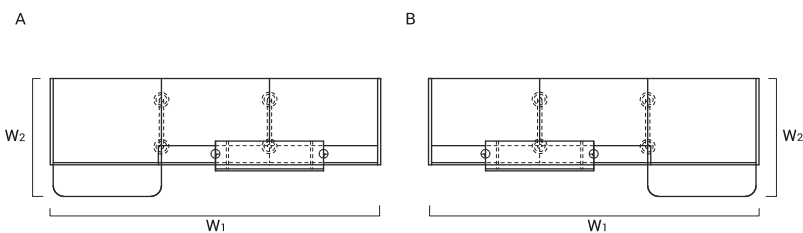
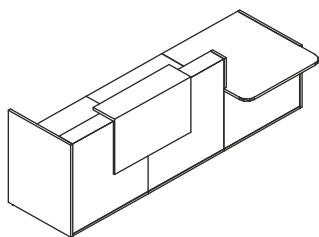

INDEX SYMBOL	DIMENSIONS [mm]						kg	m3	pcs	COMPONENTS
	W ₁	W ₂	D ₁	D ₂	H					
A TRA39L	3056	1120	-	-	1159		145.5	0.596	9	TR1L+2xTR10+TR2P+TR11+TR3P+TR99+2xNL41
B TRA39P	3056	1120	-	-	1159		145.5	0.597	9	TR3L+TR11+TR2L+2xTR10+TR1P+TR99+2xNL41
A TRA40L	3456	1120	-	-	1159		153.5	0.620	9	TR1L+2xTR12+TR2P+TR11+TR3P+TR99+2xNL41
B TRA40P	3456	1120	-	-	1159		153.5	0.621	9	TR3L+TR11+TR2L+2xTR12+TR1P+TR99+2xNL41
A TRA41L	3856	1120	-	-	1159		157.5	0.645	9	TR1L+2xTR14+TR2P+TR11+TR3P+TR99+2xNL41
B TRA41P	3856	1120	-	-	1159		157.5	0.645	9	TR3L+TR11+TR2L+2xTR14+TR1P+TR99+2xNL41

DESCRIPTION

- NET WEIGHT

VOLUME

NUMBER OF PACKAGES

PRODUCT ILLUSTRATION	DIMENSIONS [mm]			INDEX SYMBOL						COMPONENTS
	WIDTH	DEPTH	HEIGHT			kg	m3	pcs		

COMPOSITION ELEMENTS

	800	818	1090	TR08		25.0	0.054	1		
	1000	818	1090	TR10		32.0	0.067	1		
	1200	818	1090	TR12		36.0	0.079	1		
	1400	818	1090	TR14		38.0	0.091	1		
	818	818	1090	TR90		36.0	0.098	2		
	1000	1120	740	TR11		30.0	0.092	1		
	1000	282	650	TR99		17.0	0.183	1		decorative lighted element
	28	820	1090	TR1L		17.0	0.035	1		side panel for high units -left
	28	820	1090	TR1P		17.0	0.035	1		side panel for high units - right
	28	182	350	TR2L		1.5	0.003	1		left upper side panel for combining low and high element
	28	182	350	TR2P		1.5	0.003	1		right upper side panel for combining low and high element

DESCRIPTION

- NET WEIGHT

VOLUME

NUMBER OF PACKAGES

PRODUCT ILLUSTRATION	DIMENSIONS [mm]			INDEX SYMBOL						COMPONENTS
	WIDTH	DEPTH	HEIGHT			kg	m3	pcs		

COMPOSITION ELEMENTS

	28	820	740	TR3L		12.0	0.025	1		left side panel for low unit
	28	820	740	TR3P		12.0	0.025	1		right side panel for low unit
	28	182	1090	TR4L		4.0	0.008	1		side panel for high units - left
	28	182	1090	TR4P		4.0	0.008	1		side panel for high units - right
	585	142	712	NL41		2.0	0.063	1		round profile leg

DESCRIPTION

- NET WEIGHT

VOLUME

NUMBER OF PACKAGES