

TECHNICAL SPECIFICATION

COLOURS

FRONT



34 CHESTNUT



64 COCOA



BODY

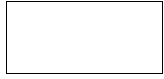

67 WHITE PASTEL

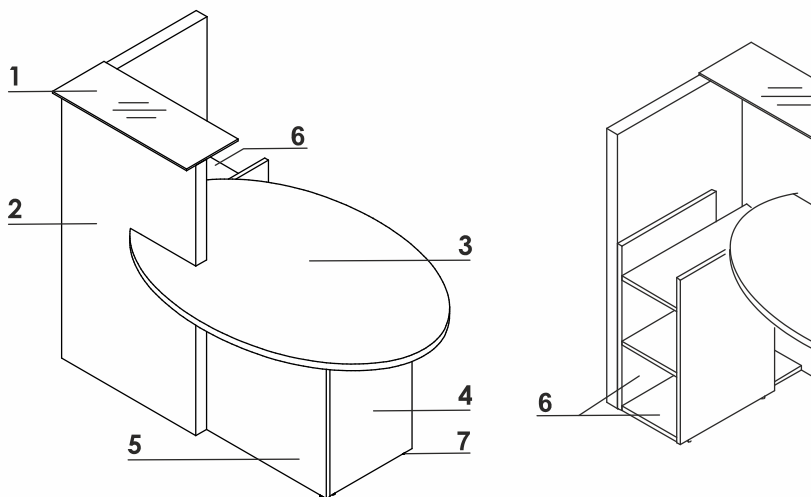
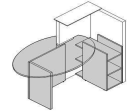

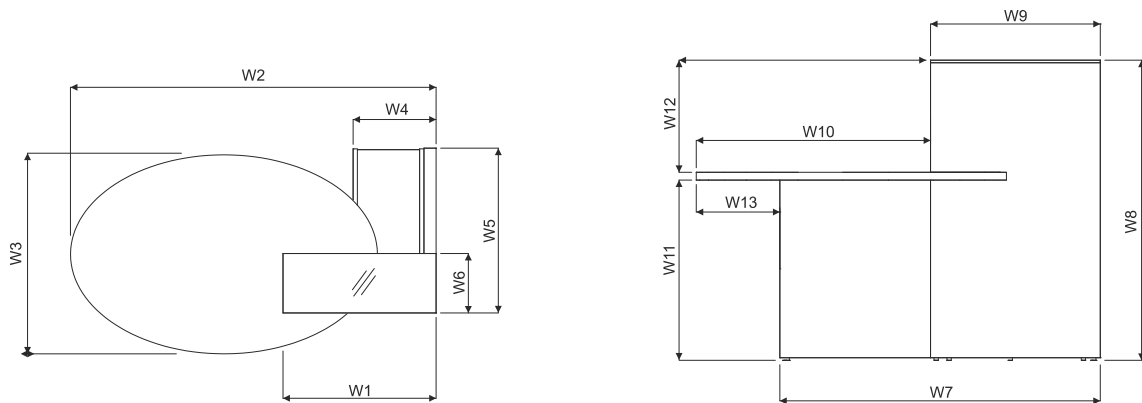

- 1. **Top** - tempered frosted glass 8mm
- 2. **Front** - MFC 52mm
- 3. **Work top** - MFC 28mm, PVC edge
- 4. **Body** - MFC 28mm, PVC edge
- 5. **Body** - MFC 18mm, PVC edge
- 6. **Dividing storage** - MFC 18mm, PVC edge
- 7. **Leveling** - 10mm range

DIMENSIONS



W1 - 650mm | W2 - 1548mm | W3 - 850mm | W4 - 352mm | W5 - 695mm | W6 - 250mm | W7 - 1230mm | W8 - 1150mm | W9 - 650mm | W10 - 900mm | W11 - 692mm | W12 - 430mm | W13 - 320mm

PRODUCT ILLUSTRATION	DIMENSIONS [mm]			INDEX SYMBOL						COMMENTS
	WIDTH	DEPTH	HEIGHT			kg	m3	pcs		

**OVO RECEPTION DESK**

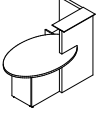
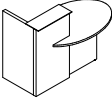
	1550	870	1150	<b>LOP10</b>		88.8	0.240	3		
	1550	870	1150	<b>LOL10</b>		88.5	0.236	3		

DESCRIPTION

 NET WEIGHT

 VOLUME

 NUMBER OF PACKAGES